

DETAIL A

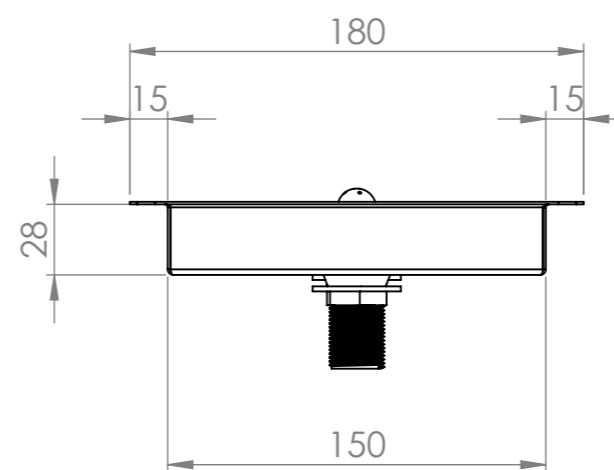

SBM-DT-GR-0300

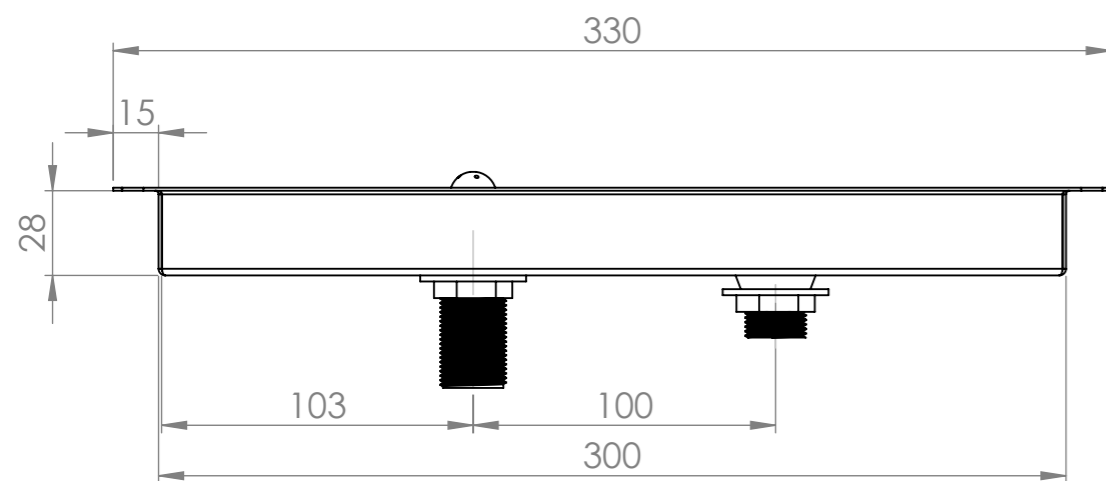
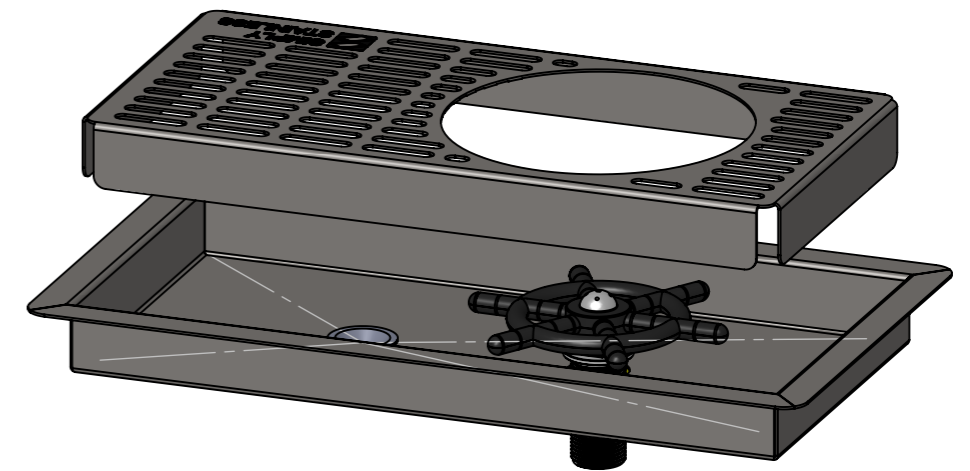

Modular Bar Solutions

COPYRIGHT © 2022

This drawing is the property of CI GROUP PTY LTD. Tradings as SIMPLY BARS and It may not be copied, reproduced or modified in whole or in part without prior written permission of CI GROUP PTY LTD. SIMPLY BARS reserves the right to change specification and design without notice.

SBM-DT-GR-0300

DROP IN DRIP TRAY WITH GLASS RINSE

SIZE: A3

SCALE : 1:3

CONSTRUCTION NOTES :

1. TOPS MADE FROM 1.2mm STAINLESS STEEL.
2. CUT OUT REQUIRED 305mm X 155mm



WMTS.101
WM-040293
SIMPLY STAINLESS
Model Number : SBM-DT-GR-0300